

Ultra Low Noise, High IP3

# Monolithic Amplifier

CMA-252LN+

50Ω 1.5 to 2.5 GHz

## The Big Deal

- Ceramic, Hermetically Sealed, Nitrogen filled
- Low profile case, .045" high
- Ultra Low Noise Figure
- High Gain, High IP3
- Class 1B HBM ESD (500V)



CASE STYLE: DL1721

## Product Overview

Mini-Circuits CMA-252LN+ is a E-PHEMT based Ultra-Low Noise MMIC Amplifier with a unique combination of low noise and high IP3 making this amplifier ideal for sensitive high dynamic range receiver applications. This design operates on a single 3 to 4V supply. The MMIC amplifier is bonded to a multilayer integrated LTCC substrate and then hermetically sealed under a controlled nitrogen atmosphere with gold-plated covers and eutectic AuSn solder. These amplifiers have been tested to MIL requirements for gross leak, fine leak, thermal shock, vibration, acceleration, mechanical shock, and HTOL.

## Key Features

Feature	Advantages
Ultra Low Noise, 0.8 dB at 1.8 GHz	Excellent noise figure performance. Increases signal to noise ratio.
High IP3, +29 dBm at 1.8 GHz	Combining Low Noise and High IP3 makes this MMIC amplifier ideal for use in Low Noise Receiver Front End (RFE) as it gives the user advantages at both ends of the dynamic range: sensitivity & two-tone IM performance.
Adjustable Current	Provides users ability to set current consumption over a wide range from 25 to 80 mA.
Ceramic Hermetic Package	Low inductance, repeatable performance, excellent reliability
Max Input Power, +27 dBm	Ruggedized design operates up to high input powers often seen at Receiver inputs eliminating the need for an external limiter.
High Reliability	Low, small signal operating current of 57 mA nominal maintains junction temperatures typically below 100°C at 85°C ground lead temperature.



Ultra Low Noise, High IP3

# Monolithic Amplifier

1.5-2.5 GHz

## Product Features

- Low Noise Figure, 0.8 dB at 1.8 GHz
- High IP3, 30 dBm typ. at 1.8 GHz
- P1dB 17 dBm typ. at 1.8 GHz
- Adjustable Current, 25 to 80 mA
- Adjustable Gain,  $\pm 1.5$  dB
- Active Bias
- Small size - 3mm x 3mm x 1.14mm
- Ceramic, hermetic, Nitrogen filled
- No external matching components required



## CMA-252LN+

CASE STYLE: DL1721

**+RoHS Compliant**

The +Suffix identifies RoHS Compliance. See our web site for RoHS Compliance methodologies and qualifications

## Typical Applications

- Base station infrastructure
- Satellite Communication (Inmarsat)
- LTE
- GPS
- Tactical Air Navigation

## General Description

The CMA-252LN+ amplifier is fabricated using E-PHEMT technology and offers extremely high dynamic range with ultra low noise figure and good input and output return loss. Terminal finish is Ni-Pd-Au and it has repeatable performance from lot to lot due to fully automated, tightly controlled semiconductor and assembly processes.

## simplified schematic and pad description

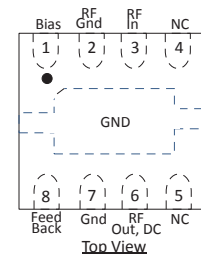
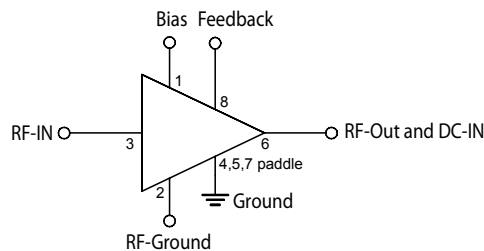

Function	Pad Number	Description
RF IN	3	Connects to RF input via C1 and Pad 2 via L1
RF-OUT	6	Connects to RF out via C2, Pad 8 via R1, and C3
RF-Ground	2	Connects to ground via C4 and Pad 3 via L1
Bias	1	Connects to Supply voltage (Vs) via Rbias
Feedback	8	Connected to pads 6, 1 via R1 and C3
Ground	7 & paddle	Connects to ground
Not connected	4,5	Recommend connection to ground

\* Enhancement mode pseudomorphic High Electron Mobility Transistor.



**Electrical Specifications<sup>(1)</sup> at 25°C, unless noted**

Parameter	Condition (GHz)	Vs=4V			Vs=3V	Units
		Min.	Typ.	Max.	Typ.	
Frequency Range		1.5		2.5		GHz
Noise Figure	1.5		0.7		0.7	dB
	1.8		0.8		0.9	
	2.0		1.0		1.0	
	2.2		1.1		1.2	
	2.5		1.3		1.3	
Gain	1.5		19.2		18.6	dB
	1.8		18.3		17.6	
	2.0		16.8		16.2	
	2.2		16.1		15.4	
	2.5		15.1		14.2	
Input Return Loss	1.5		19.0		14.0	dB
	1.8		15.0		12.4	
	2.0		13.8		11.8	
	2.2		13.0		11.6	
	2.5		12.5		11.1	
Output Return Loss	1.5		10.0		10.6	dB
	1.8		22.5		26.0	
	2.0		16.5		16.0	
	2.2		11.2		10.8	
	2.5		7.6		7.1	
Output Power @ 1 dB compression <sup>(2)</sup>	1.5		18.5		16.2	dBm
	1.8		17.9		15.9	
	2.0		17.8		15.6	
	2.2		17.4		15.3	
	2.5		16.1		13.9	
Output IP3	1.5		31.1		27.1	dBm
	1.8		30.1		25.5	
	2.0		30.0		25.3	
	2.2		29.3		24.8	
	2.5		27.6		23.2	
Device Operating Voltage		3.8	4.0	4.2	3.0	V
Device Operating Current at typ. voltage <sup>(2)</sup>			57	70	41	mA
DC Current Variation Vs. Temp. at typical voltage <sup>(3)</sup>			-19		-3.4	µA/°C
DC Current Variation Vs. Voltage			0.018		0.017	mA/mV
Thermal Resistance			53		53	°C/W

<sup>(1)</sup> Measured on Mini-Circuits Characterization test board TB-759+. See Characterization Test Circuit (Fig. 1) R1=825Ω, R<sub>bias</sub>=619Ω

<sup>(2)</sup> Current increases at P1dB

<sup>(3)</sup> (Current at 85°C - Current at -45°C)/130

**Absolute Maximum Ratings<sup>(4)</sup>**

Parameter	Ratings
Operating Temperature (ground lead)	-55°C to 105°C
Storage Temperature	-65°C to 125°C
Junction Temperature	150°C
Total Power Dissipation	0.55 W
Input Power (CW), Vs=3V or 4V	+25 dBm (5 min. max) +20 dBm (continuous)
DC Voltage	5.5V

<sup>(4)</sup> Permanent damage may occur if any of these limits are exceeded. Electrical maximum ratings are not intended for continuous normal operation.

DC Current Histogram at Vs=4V

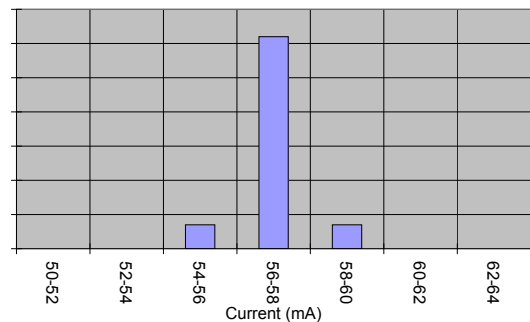

Recommended Application and Characterization Test Circuit

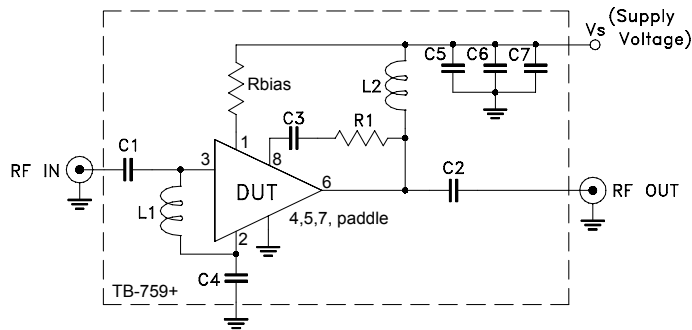

Fig 1. Application and Characterization circuit

Note: This block diagram is used for characterization. (DUT soldered on Mini-Circuits Characterization test board TB-759+) Gain, Return loss, Output power at 1dB compression (P1 dB), output IP3 (OIP3) and noise figure measured using Agilent’s N5242A PNA-X microwave network analyzer.

Conditions:

1. Gain and Return loss: Pin= -25dBm
2. Output IP3 (OIP3): Two tones, spaced 2.5 MHz apart, 2 dBm/tone at output.

Suggested PCB Layout (PL-405)

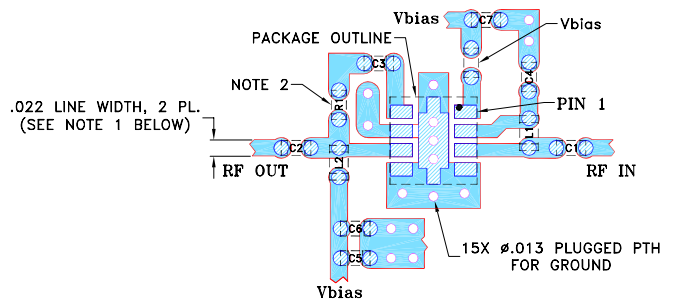
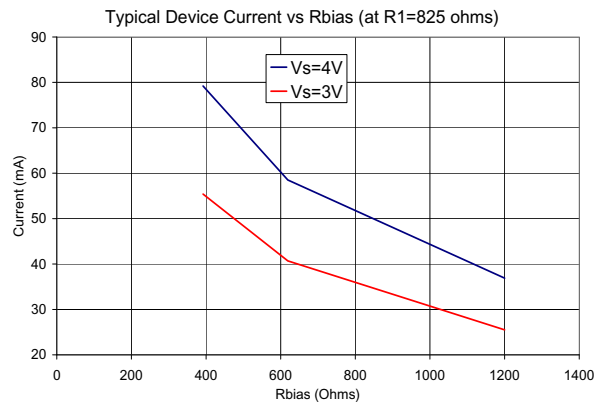

- NOTES: 1. TRACE WIDTH IS SHOWN FOR ROGERS RO4350B WITH DIELECTRIC THICKNESS .010" ± .001"; COPPER: 1/2 OZ. EACH SIDE. FOR OTHER MATERIALS TRACE WIDTH MAY NEED TO BE MODIFIED.  
 2. 0402 SIZE CHIP FOOT PRINTS SHOWN FOR REFERENCE, FOR COMPONENT VALUE REFER TO TB-759+.  
 3. BOTTOM SIDE OF THE PCB IS CONTINUOUS GROUND PLANE.
- DENOTES PCB COPPER LAYOUT WITH SMOBC (SOLDER MASK OVER BARE COPPER)
  - DENOTES COPPER LAND PATTERN FREE OF SOLDER MASK

Product Marking

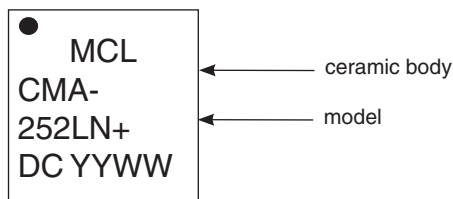

Adjustable Gain Performance (vs. R1) at Vs=4V

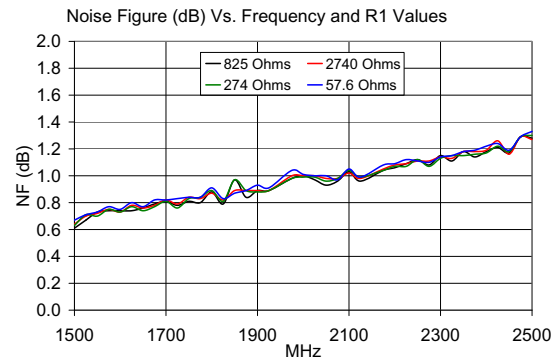
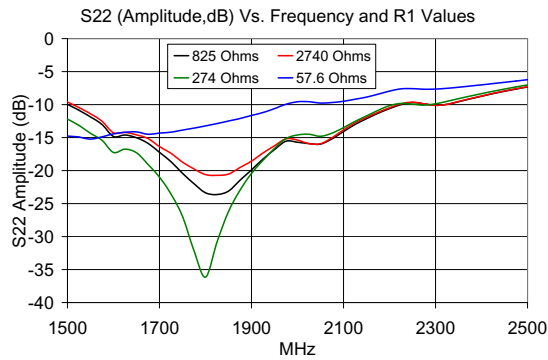
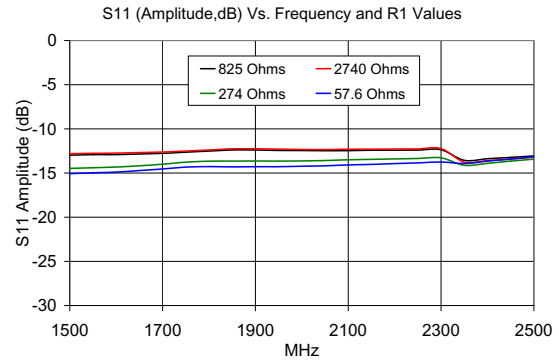
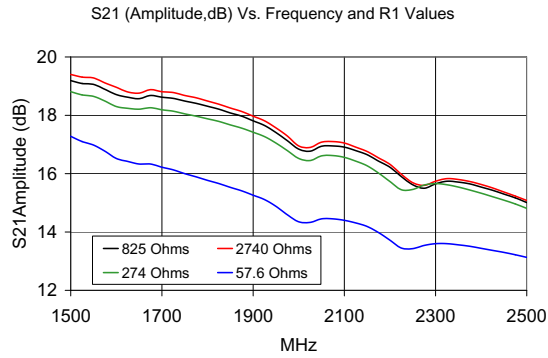

Adjustable Gain Performance (vs. R1) at Vs=3V

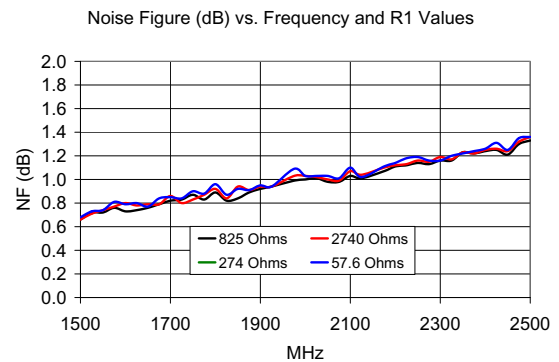
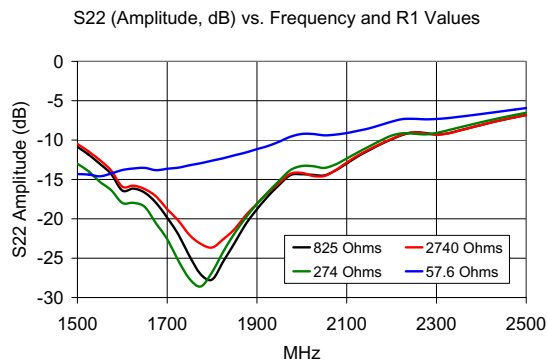
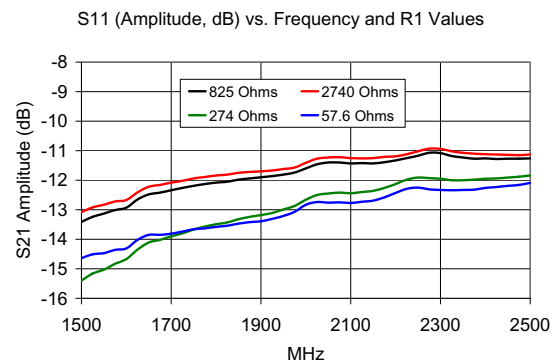
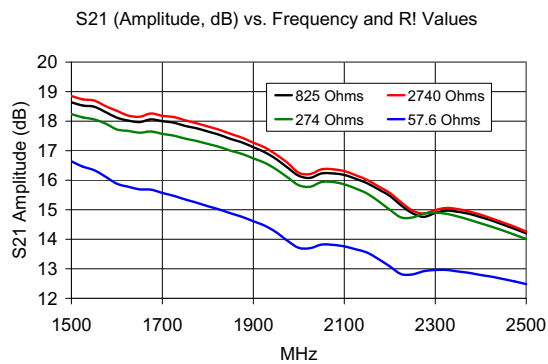

<b>Additional Detailed Technical Information</b>	
<i>additional information is available on our dash board. To access this information <a href="#">click here</a></i>	
<b>Performance Data</b>	Data Table
	Swept Graphs
	S-Parameter (S2P Files) Data Set (.zip file)
<b>Case Style</b>	DL1721 <i>Ceramic package, exposed paddle, Terminla finish: NiPdAu</i>
<b>Tape &amp; Reel</b> Standard quantities available on reel	F66-1 <i>7" reels with 20, 50, 100, 200, 500 or 1K, 2K devices.</i>
<b>Suggested Layout for PCB Design</b>	PL-406
<b>Evaluation Board</b>	TB-759+
<b>Environmental Ratings</b>	ENV-68

## ESD Rating

Human Body Model (HBM): Class 1A (250 to <1000V) in accordance with ANSI/ESD STM 5.1 - 2001

Machine Model (MM): Class M1 (pass 25V) in accordance with ANSI/ESD STM5.2-1999

## MSL Rating

Moisture Sensitivity: MSL1 (these parts are hermetic, air cavity and therefore, MSL ratings do not strictly apply. For handling purpose, use MSL1)

## Qualification Testing

Test Description		Test Method/Process	Results
1	Hermeticity (fine and gross leak)	MIL-STD-202 Method 112, Cond. C & D	Pass
2	Acceleration, 30Kg, Y1 Direction	MIL-STD-883 Method 2001 Cond. E	Pass
3	Vibration , 10-2000Hz sine, 20g, 3 axis	MIL-STD-202 Method 204, Cond. D	Pass
4	Mechanical shock	MIL-STD-202 Method 213, Cond . A	Pass
5	PIND 20G's @130 Hz	MIL-STD-750 Method 2052.2	Pass
6	Temp Cycle -55C/+125C, 1000 Cycles	MIL-STD-202 Method 107	Pass
7	Autoclave, 121C, RH 100%, 15 Psig, 96 hrs	JESD22-A102C	Pass
8	HTOL, 1000hrs, 105C at rated Voltage condition	MIL-STD-202 Method 108, Cond . D	Pass
9	Bend Test	JESD22-B113	Pass
10	Resistance to soldering heat, 3x reflow, 260C peak	JESD22-B102	Pass
11	Drop Test	JESD22-B111	Pass
12	Adhesion Strength	Push Test>10 lb	Pass

## Additional Notes

- Performance and quality attributes and conditions not expressly stated in this specification document are intended to be excluded and do not form a part of this specification document.
- Electrical specifications and performance data contained in this specification document are based on Mini-Circuit's applicable established test performance criteria and measurement instructions.
- The parts covered by this specification document are subject to Mini-Circuits standard limited warranty and terms and conditions (collectively, "Standard Terms"); Purchasers of this part are entitled to the rights and benefits contained therein. For a full statement of the Standard Terms and the exclusive rights and remedies thereunder, please visit Mini-Circuits' website at [www.minicircuits.com/MCLStore/terms.jsp](http://www.minicircuits.com/MCLStore/terms.jsp)

